

INDUSTRIAL SOLUTIONS

CONDITION MONITORING

OF PROCESSES, PLANTS AND COMPONENTS



1	Overview
2	Technology
4	Manufacturing industry
8	Energy sector
12	Transportation
14	Bio- and medical technology
16	Cooperation models
17	Technical equipment

COVER *Safe wind turbines are a pillar of the energy turnaround.*

1 *Condition monitoring of tape casting processes at Fraunhofer IKTS.*

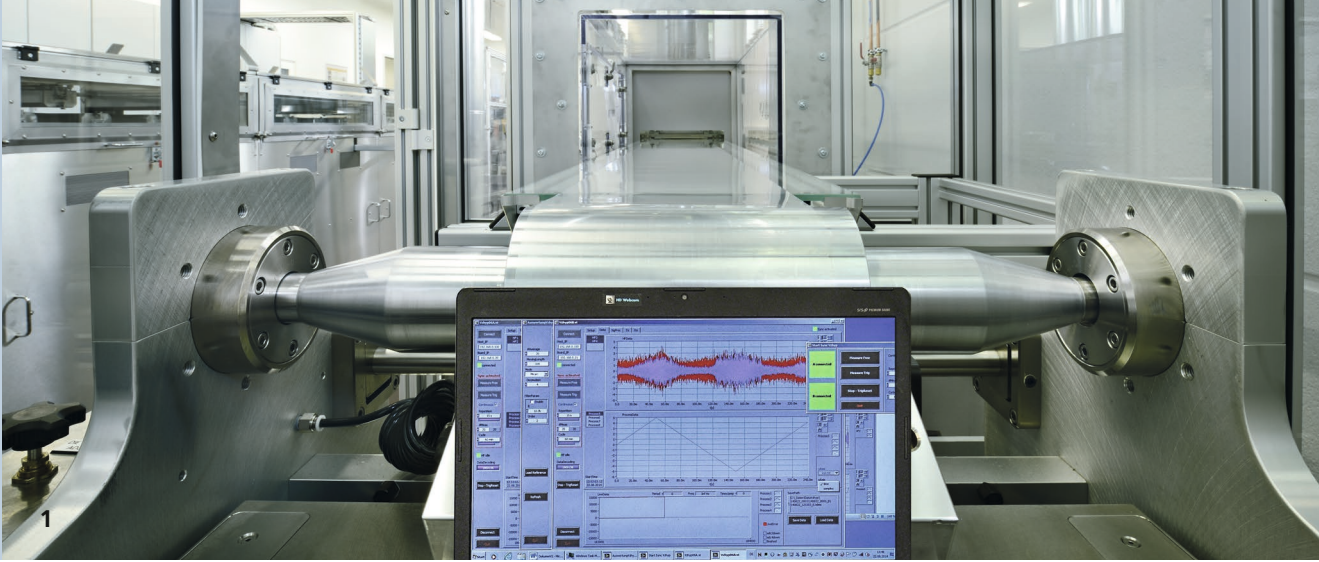

IMPROVED RELIABILITY, REDUCED COSTS

Methods and measuring systems for condition monitoring (CM) ensure the availability of plants and machinery. The regular collection of machine conditions and states can provide decisive information needed for maintenance, repair and operations (MRO) strategies, for better control and optimized processes. Static components, by contrast, can be monitored automatically with structural health monitoring (SHM). SHM detects and assesses damage mechanisms and ensures the reliability and optimal function of critical components.

Fraunhofer IKTS is a competent partner when it comes to monitoring materials, components, assemblies, plants and machinery as well as the pertaining manufacturing methods. This includes the analysis and assessment of components and processes, as well as their optimization.

For this purpose, IKTS develops sensors (optical, acoustic, electromagnetic), systems and techniques for condition monitoring, which are implemented while plants are being built and taken into operation. These systems can also be installed in existing infrastructures. They are designed for harsh conditions and offer tools for the non-destructive detection of defects, real-time monitoring and, associated with this, condition-based maintenance or optimization of plants.

The customized solutions help to improve plant safety in full compliance with all standards. They are developed in close cooperation with machine manufacturers and users.

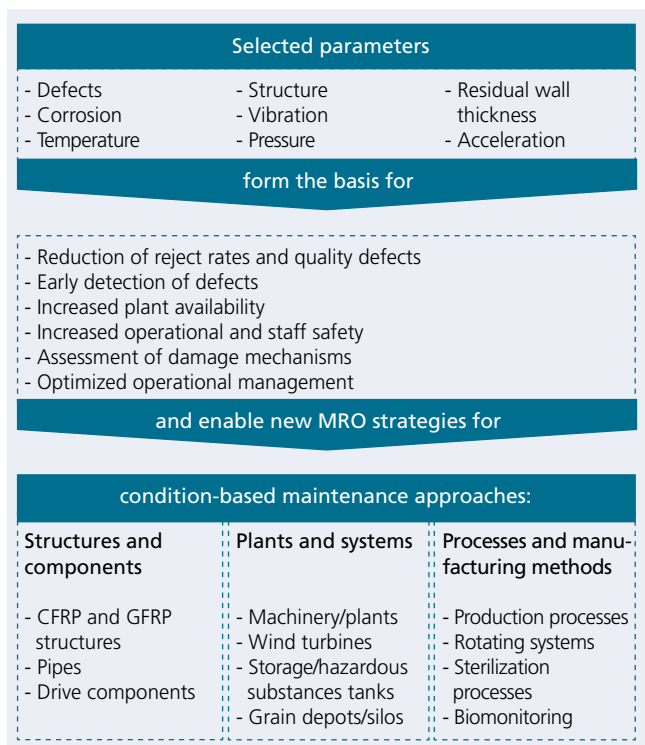



TECHNOLOGY

Every CM system is unique: Corrective, informative or predictive – only a customized maintenance strategy will lead to a longer service life and cost savings. CM systems by Fraunhofer IKTS focus on identifying, recording and assessing the decisive parameters. The intelligent systems may predict damage based on probabilities, increasing the availability of plants and components.

Fraunhofer IKTS develops, builds and integrates measuring systems for condition monitoring depending on their intended use, i.e. for processes, plants or components. Depending on operating conditions and client requirements, the systems can either be installed temporarily or remain on the structure for a longer period of time.

The decision on whether monitoring should be permanent depends on the length of measuring intervals and the required resolution capability of the results.

When several sensors are combined in a network, it becomes possible to correlate several measuring parameters, in addition to monitoring extensive structures.

In order to minimize interference with the monitored object and its environment, the condition monitoring systems can be combined with wireless technology developed at IKTS, as well as autonomous energy supply units.

The aim of condition-based monitoring is to improve resource planning and design MRO processes in accordance with actual needs.

Condition monitoring as a holistic concept

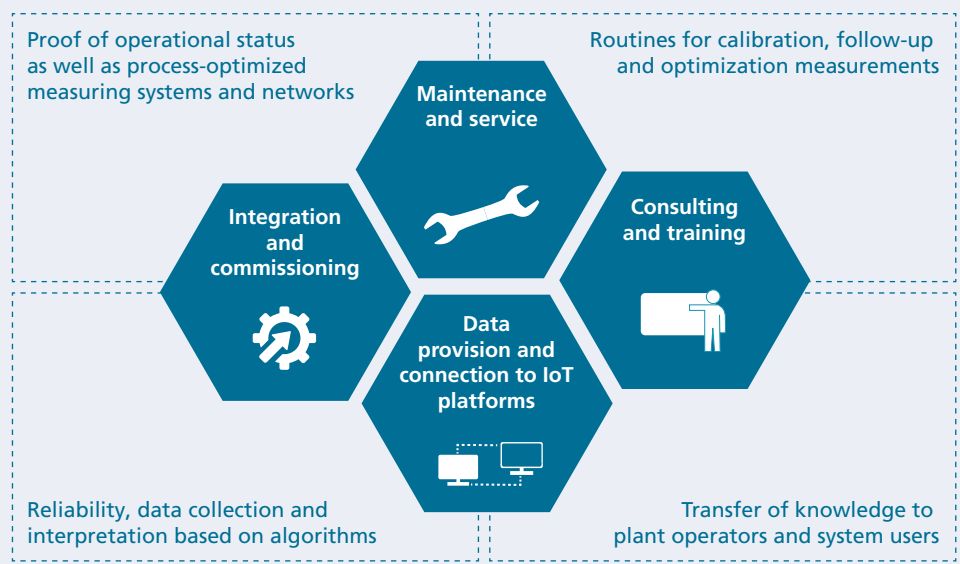

1 CoMoBelt: Sensor ring for monitoring weld seams or abrasion rates on pipes.



The path to a client-specific condition monitoring system

Simulation	Measuring principle	Sensors	Electronics	Data processing	Energy supply	Integration	Accreditation
Modeling of damage interactions	Deduction of damage-relevant measured quantities	Sensor design, reliability for long-term measurements	Design of test electronics	Compensation of environmental factors	Energy supply according to needs	Various sensor applications and integration	Accredited in-house center for non-destructive materials testing*
Design and optimization of transducers	Theoretical considerations of damage interactions	Acoustic, electromagnetic, optical, acceleration sensors	Taking into account ambient conditions	Extraction of defects Application-specific programming	Wired/wireless, optical, battery-powered	Embedding in various materials (CFRP, GFRP) Explosion-proof sensor housings	Inspection services, design studies, validation of test methods

Therefore the requirements for a truly innovative monitoring system go beyond the scope of a traditional implementation, i.e. the integration of individual sensors or extensive sensor networks including professional commissioning.

Fraunhofer IKTS actively pursues the approach of a complete condition monitoring management – from conceptualization to final integration. Our close partnerships with the industry and with other research institutions allow us to connect monitoring systems to available IoT platforms, based on universal interfaces and using the latest automation architectures. This includes not only the vertical integration of the recorded data, but also horizontal data provision for subsequent processes.

The data are consolidated to obtain conclusive information before being transferred via safe networks. The web-based presentation of data can take place in a user-friendly way, on mobile terminal devices.

This holistic approach is completed by client-specific consulting services and training options for employees.



2 *Safety-relevant areas in industry require special concepts for CM systems.*

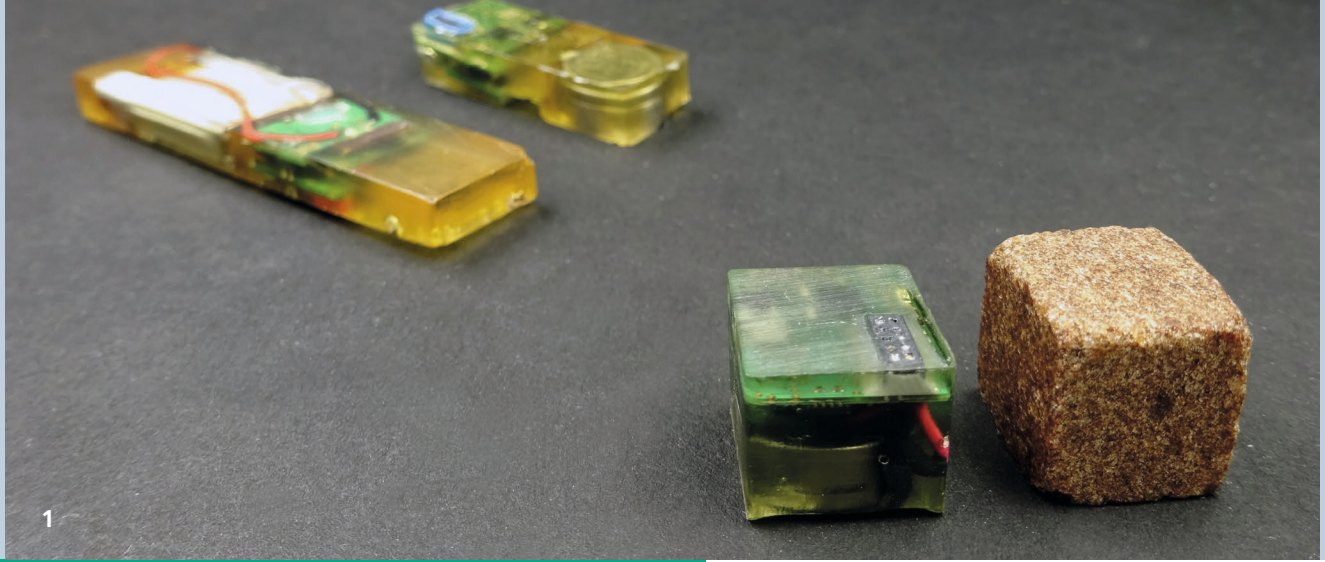

1

MANUFACTURING INDUSTRY

Manufacturing processes are the main focus of operational performance. They decide on a company's competitive advantage. With its process know-how, Fraunhofer IKTS contributes to the design of efficient and safe manufacturing processes in many branches of the industry. The core area is the fast, contactless monitoring of materials, components and whole plants using acoustic and optical test methods.

MINIATURE SENSORS FOR PACKAGING PROCESSES

The ad-hoc collection of data in a packaging process enables fast troubleshooting in case of malfunction, as well as short response times with regard to spare parts provisioning. This increases plant availability and also makes it possible to identify areas within the running process where products are subjected to stress.

In many cases, stress cannot be measured on the packaging machine, but only on the packaged product itself. For this reason, Fraunhofer IKTS has developed a miniature sensor system which supplies diagnostic information on the process while delivering and assessing defect identification in real time.

The encapsulated sensor system runs through the packaging process in the shape of the product, e.g. a chocolate bar or a stock cube. It measures various parameters, such as vibrations, temperature or pressure. Furthermore accelerations can be measured on three axes with various sampling and rotation rates during the run through the packaging machine. Numerous series of measurements are recorded with the integrated data storage.

After running through the packaging process, the sensor system is sorted out using electromagnetic localization.

Before the measurement takes place, the sensor construction is configured via a PC interface. The measurement itself is contactless, thanks to integrated Hall sensors via an external magnetic field. A rechargeable battery ensures a long service life of the sensor module. Based on the developed system platform, specific client requests can be realized, such as wireless data communication or charging technology.

Services offered

- Detection and recording of accelerations on three axes, up to 2000 m/s with a sampling rate of up to 10 kHz
- Detection and recording of rotation rates up to 4000°/s with up to 1 kHz
- Sensor system with a modular setup

OPTIMIZATION OF PROCESSES AND PLANTS

The permanent monitoring of plants is a way to ensure that critical components function flawlessly. 3D laser vibrometry enables the fast, contactless measurement of vibrations. The combination with the latest sensor technology leads to tailored solutions for permanent condition diagnostics for processes and plants.

The detection and analysis of vibrations in three dimensions allows the detailed recognition of sources of defects. On this

1 Miniaturized and integrated sensors for the monitoring of packaging processes.

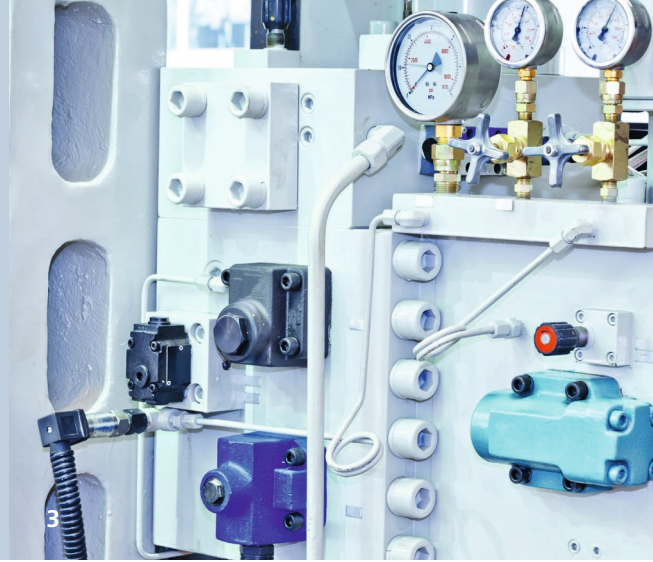
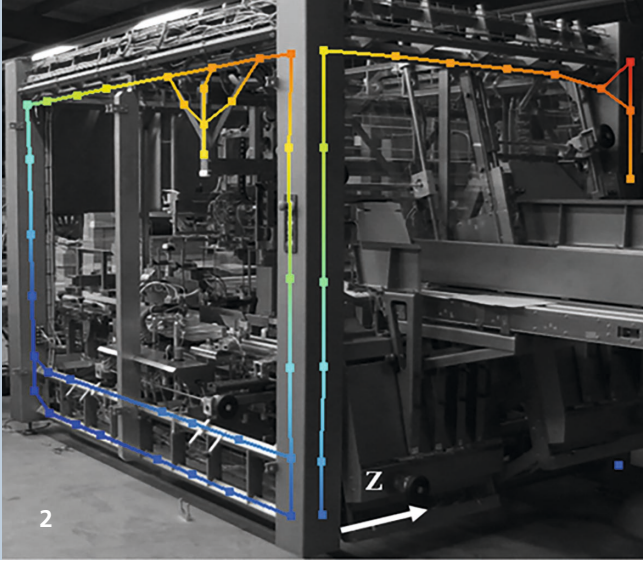

Condition monitoring with Industry 4.0

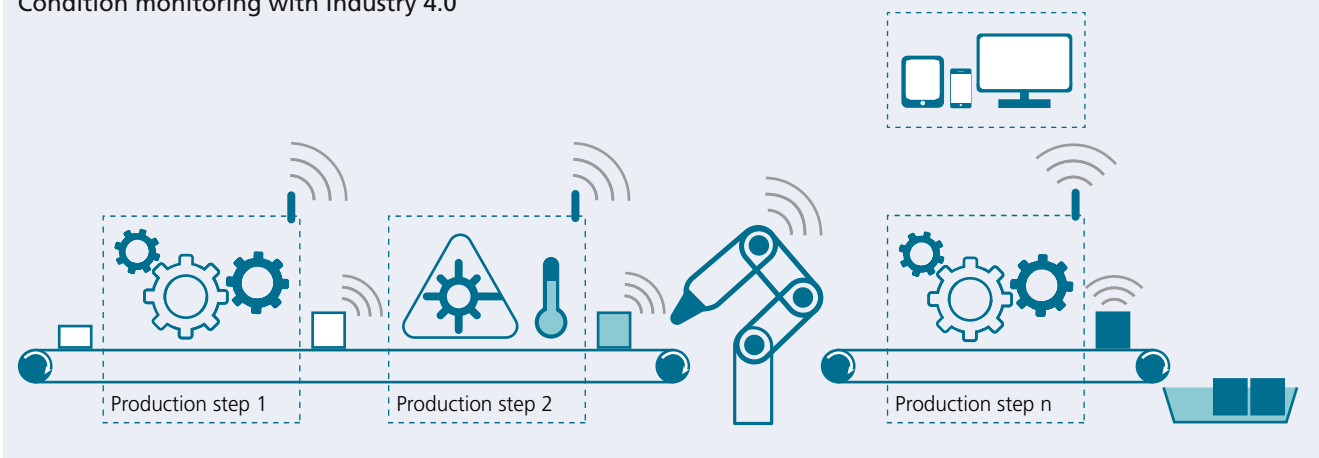

basis the design of plants and machinery may be adapted for the reduction of vibrations. In addition to the detection of operational vibrations and natural modes, three-dimensional expansion can also be detected.

Services offered

- Process and plant optimization through contactless 3D vibration analysis
- Recording of 3D wave propagation to determine the radiation pattern of sensors
- Modal analysis and three-dimensional expansion measurements
- Measured data as the basis for FEA model comparison

frequency range of 10 to 500 kHz. The hydraulic process can be described by a characteristic pattern. Changes of the condition of the component through which the medium flows result in signal variations. The envelopes of the time signals and the amplitude spectrum of the signals allow to extract features that can provide early insights into defect components or faulty system configurations. This makes predictions of necessary maintenance operations possible.

Services offered

- Sensors and systems for wear monitoring
- Adapted systems for hydraulic test stands
- Client-specific contract research

MONITORING OF HYDRAULIC COMPONENTS

Fraunhofer IKTS can provide a monitoring strategy for hydraulic components at risk from wear, such as servo valves. Structure-borne noise sensors record acoustic signals at a valve. These signals are generated by the oil flow and cover a very

2 *Vibration analysis at a packaging unit (source: J+P Maschinenbau).*

3 *Servo valves at risk of wear in hydraulic test stands.*

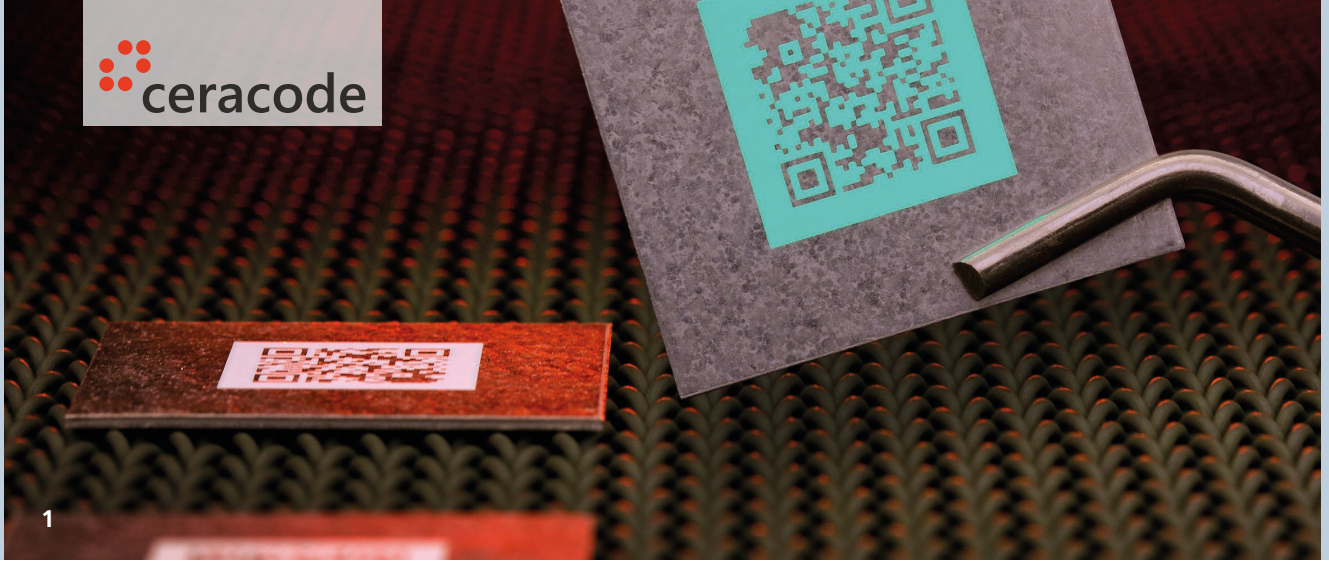

CERACODE® COMPONENT LABELING

The individual marking of components (direct part marking) plays a central role in the progressing digitization of manufacturing. It is the starting point for the clear machine identification of all components – from raw material to end product. It enables further optimization of manufacturing processes and their quality assurance by complete digital registering and interconnecting of all production elements.

An unresolved challenge is the harsh production conditions. Many processing steps performed on semi- and finished products are carried out at temperatures between 700 and 1200 °C. Surface treatments (e.g. hardening, nitrating) and cleaning processes are often subject to aggressive chemical conditions. This leads to the destruction and illegibility of common markings. Thus, a continuous recording of the components is not possible.

Ceracode® is a complete solution for the marking and identification of metal parts in hot forming. It is based on a matrix code consisting of a ceramic-pigmented ink, which is applied using well-established printing methods.

The code forms a solid bond with the part, withstands the highest temperatures and is resistant to chemical media. The part's properties are not affected by it. A module consisting of scanner and lighting unit makes for high-contrast reading and identification of the coding, and transmits the data to the client's data systems via industry-standard hardware and software interfaces.

Thus, the Ceracode® direct part marking method opens up new models of digital value creation in sectors and areas of manufacturing where automated data collection has not been available to date.

Services offered

- Selection of components for printing according to process parameters
- Production of the marking ink for optimal bonding, fast drying and maximum contrast
- Planning of a marking and registration solution to suit the extent of the information to be printed, component size and required resolution
- Development of a customized system for printing, adaptation of the fully automatic reading system and integration in an existing manufacturing line with interface to process control

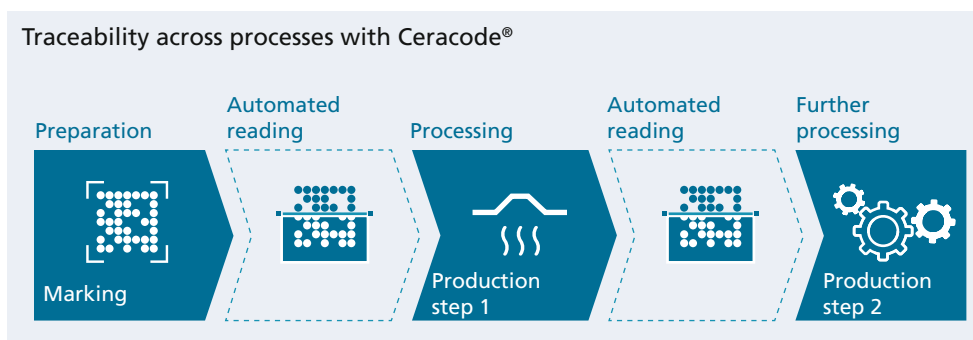

1 High-contrast, temperature-resistant marking on metal part.

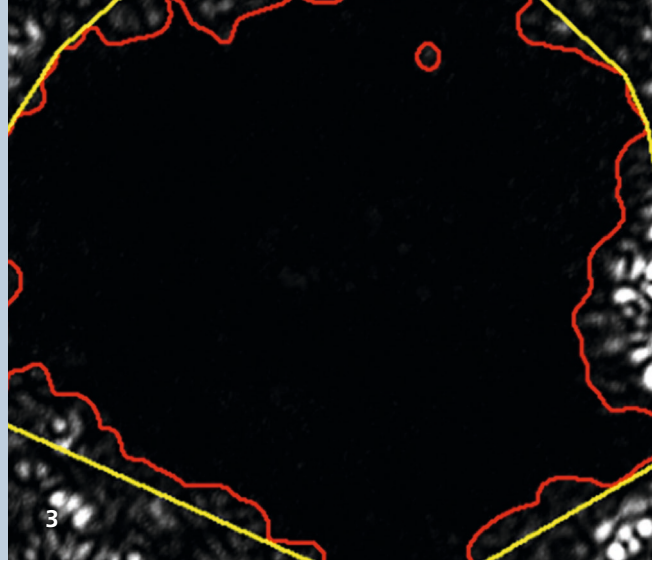
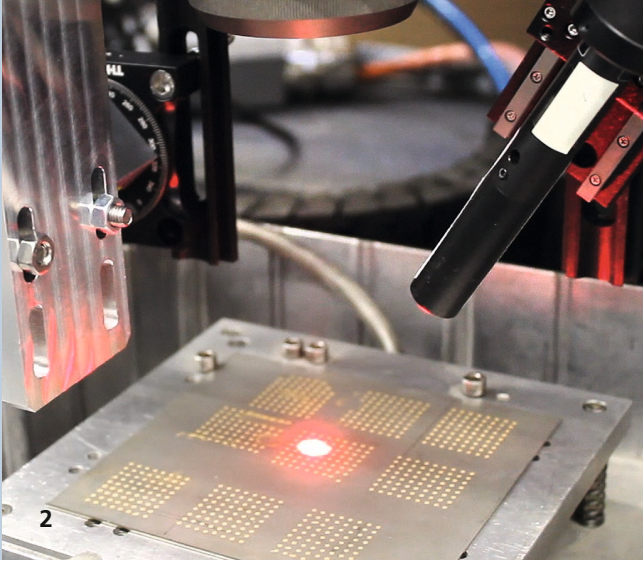

MONITORING OF WELDING PROCESSES

Micro laser metal deposition is used to manufacture gold contacts for electronics (e.g. sliding contacts or plugs). Parallelization allows to functionalize dozens of contacts per second. This requires a fast 100 percent control.

Fraunhofer IKTS offers a unique measuring and testing solution for this welding process. In-line monitoring using laser speckle photometry (LSP) allows to identify and collect material properties, tensions and surface defects as well as geometrical dimensions fast and efficiently without contact. The method analyzes the changes over time of optical speckle patterns (interference patterns) which develop when the test object is irradiated by coherent light. The LSP system determines the precious metal content of up to 100 contacts per minute and is able to identify their geometry at the same time. This means that laser speckle photometry is much faster than other test methods.

Services offered

For manufacturing processes with large production runs, LSP enables the detection of defects for almost all material classes. Beyond the development of client-specific full-scale LSP-based test systems for laser metal deposition processes, Fraunhofer IKTS also offers LSP test solutions for other fields of application:

- Process monitoring (e.g. porosity/defects) for additive manufacturing processes
- Monitoring of biotechnological processes
- In-line quality control for high-volume manufacturing
- Tension monitoring of large components with fatigue stress (load-bearing elements, bridges)
- On-site measuring service

Calibrating curve of the height of contacts via confocal microscopy versus LSP

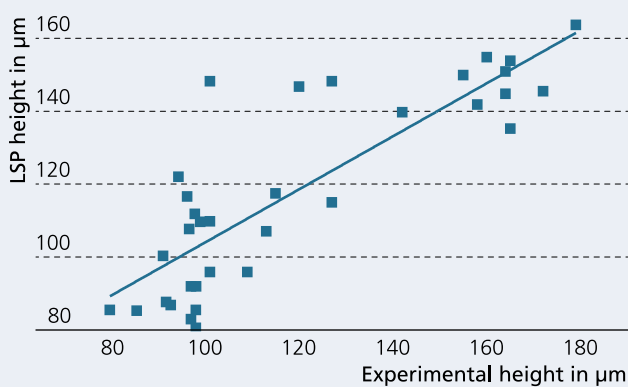

2 Automated online test system based on laser speckle photometry (LSP).

3 Speckle pattern of a gold contact from which the contact height is determined.



ENERGY SECTOR

Safety and reliability are essential for large-scale plants. Monitoring of critical components, such as rotor blades or pipes, helps to prevent downtime and reduce maintenance costs. Fraunhofer IKTS offers various systems for the condition monitoring of onshore and offshore plants. Furthermore, IKTS is available as a service provider for supporting fatigue tests and for instrumentation, operation and the evaluation of measuring results.

MONITORING OF TANKS

With CoMoDetect®, Fraunhofer IKTS offers a system solution for the condition monitoring of storage tanks in safety-relevant industrial areas, which determines the structural integrity by analyzing specific ultrasonic waves. The monitoring system uses active signature analysis as well as passive acoustic emission analysis.

CoMoDetect® was developed specifically for the permanent monitoring of hard-to-access vessels and other corrosion-prone components in explosion-proof environments. The system consists of a network of sensors (CoMoSens® Ex) and an electronic data logger (CoMoBase® Ex). The distances between the sensors define the area to be monitored. To obtain a good crack depth detection, the spatial resolution is about a fourth of the vessel's wall thickness. In order to increase the spatial resolution in critical areas, multiple sensors can be coupled to obtain clusters.

The sensors are mounted to the vessel with well-established welding methods, which makes installation fast and easy. Sensors, which are certified for different temperature ranges, are

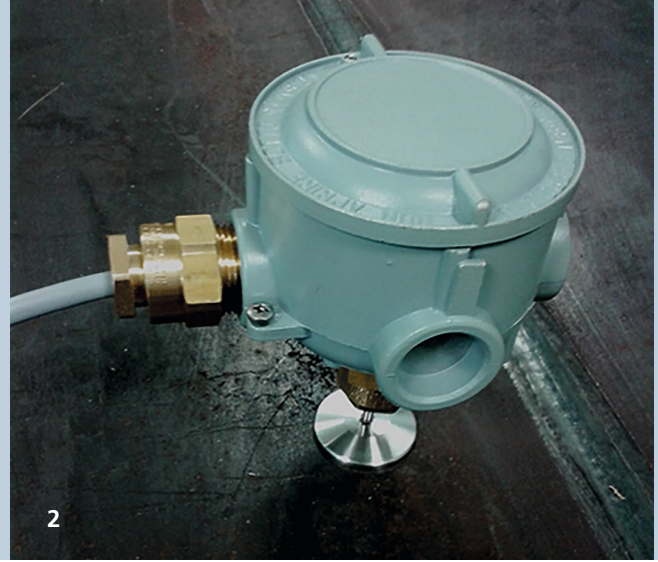

2

thus mounted permanently to the vessel. This enables continuous measuring over longer time periods. The monitoring system can be extended at any time.

Services offered

- Vessel monitoring in industrial plants
- Crack detection and corrosion monitoring for chemical plants, refineries, etc.

Visualization of the damage interaction at a pipeline (C scan)

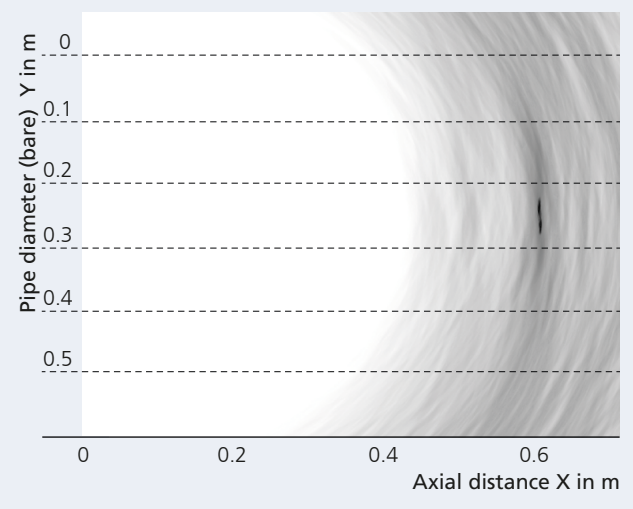

- 1 Storage tanks in an explosion-protected area.
- 2 CoMoSens® for weld seam monitoring at a tank.

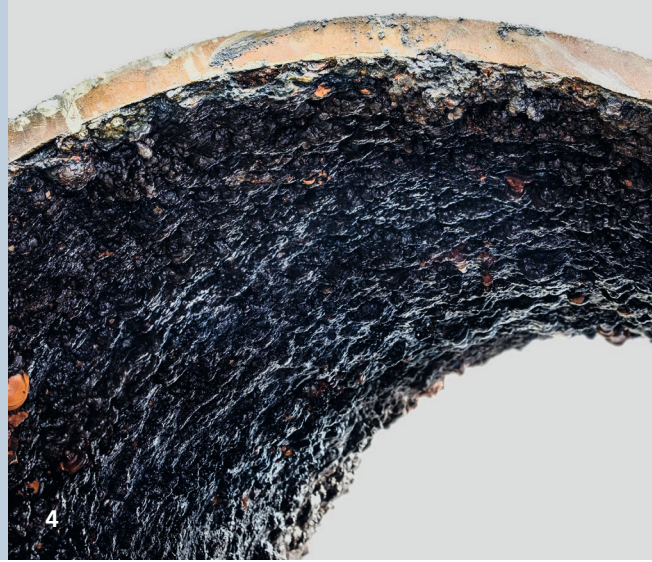

MONITORING OF PIPES

Corrosion, deposits, biofilm, fouling or other foreign materials affect the integrity of pipelines and may even lead to complete destruction. For this reason, operators of very long pipeline networks in particular strive to implement maintenance and service operations as efficient as possible.

With CoMoRanger®, Fraunhofer IKTS offers a monitoring system specifically for corrosion-prone components that are difficult to access. It is used in particular where conventional test pigs fail. The system detects defects and continuously determines the residual wall thickness in the case of extensive corrosion at above-ground, underground or vertical pipes.

For this purpose, CoMoRanger® sends low-frequency ultrasonic waves, called guided waves, into the components to check their condition. Since guided ultrasonic waves travel nearly undamped across wide distances in pipes, extensive structures can be examined from one single location. This reduces the effort for testing, with regard to both the mere measuring time and the requirements regarding the reliability of the component.

The monitoring system by Fraunhofer IKTS is easy to install. The sensors are pressed onto the pipe to be tested using a steel belt; they remain permanently mounted to the test object.

CoMoRanger® reduces the effort for recurring routine inspections and predictive maintenance. It also helps to avoid unnecessary digging and the removal of coating or scaffolding in case of defect-free pipes. This leads to savings in operating costs.

Services offered

- CoMoRanger® (number of sensors as required)
- Electronic data logger
- System design as per requirement (e.g. as an autonomous measuring system with flash memory storage)

The working principle of guided waves on pipes

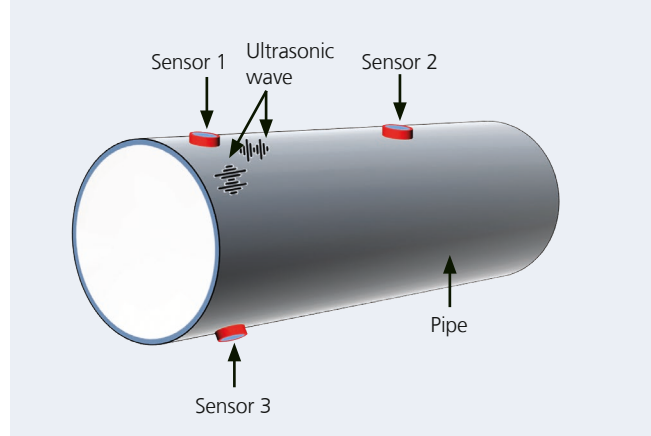

3 Reliable operation of supply pipes.

4 Loss of integrity of pipelines due to corrosion on the pipe interior (source: designbydxl shutterstock.com).

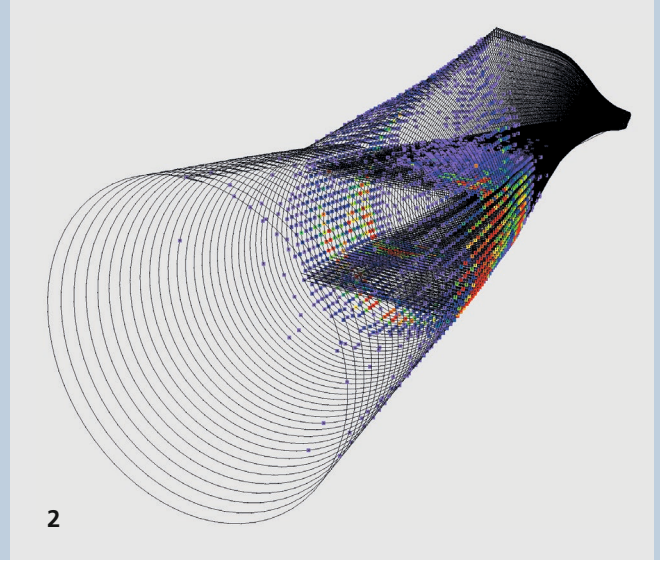

ROTOR BLADE MONITORING

Wind turbines are among the world's most important technologies for sustainable energy supply and have become an indispensable part of the renewable energy mix. Climate objectives are not just about increasing the installed capacity, e.g. through more wind farms. Improving operating efficiency is just as important. This includes undisturbed operation as well as lower maintenance costs.

Damage to the rotor blade, e.g. from lightning strike, bird impact or aerodynamic imbalance, results in enormous costs. In most cases on-site repair is the most economical option, when information on location, extent and type of damage is available. With this in mind, Fraunhofer IKTS has developed a system for the monitoring of rotor blades, ready for integration and realized with optical energy and data transmission. The latter feature is necessary as no metal conductors are allowed in the rotor blade for lightning protection reasons.

The system uses the passive method of acoustic emission testing to detect defects in the rotor blade structure. This method analyzes special ultrasonic waves which occur when the structure is under stress. Those waves are detected by piezoelectric sensors. The accumulation and distribution of the located acoustic emission events represent the current damage situation.

An analysis of the sensor data allows to localize the damage accurately. This simplifies repair operations. In the best-case scenario, it prevents the replacement of the whole rotor blade.

Fraunhofer IKTS thus offers a monitoring system that enables the evaluation of the component condition until the next scheduled inspection and helps to optimize service operations.

Depending on the company's insurance, the use of the system may even slow down the loss of value of certain components of a wind turbine, contributing to its value retention.

Services offered

- During rotor blade development: support of static and dynamic testing using the most advanced measuring technology with subsequent evaluation of the data
- In operation: monitoring of known and repaired defect locations by a subsequent installation of the system

1 Rotor blades of a wind turbine.

2 Localization plot of an acoustic emission analysis of a rotor blade.

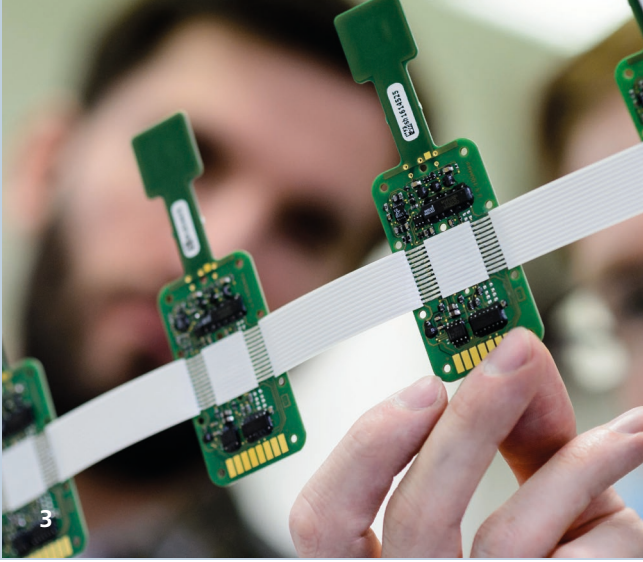

OFFSHORE FOUNDATION STRUCTURES

The rise of renewable energy technologies also means that the number of offshore wind turbines is growing worldwide. Offshore locations are usually characterized by much higher wind speeds than inland locations. On the one hand, this makes for much higher yields. On the other hand, offshore wind farms have to withstand much higher loads than their counterparts on land.

At the same time, maintenance operations are made much more difficult by the rough weather conditions on the high seas. This significantly increases operating and maintenance costs.

The difficult conditions on the high seas severely limit the options for damage detection with conventional testing methods. The enormous forces caused by the wind turbine's own weight, by water currents and waves in connection with the dynamic loads from the operation on the foundation structure may lead to damages, such as cracks in weld seams. Fraunhofer IKTS has developed CoMoBelt – a sensor ring specifically for the detection of such damages in offshore environments. The sensors are distributed as a ring around the loaded spots and adapted to the specific requirements. A number of barrier layers protect the sensors and other electronic parts by permanently preventing seawater penetration.

Fresnel volume migration provides data analysis for imaging. Environmental data, such as temperature or air humidity, are additionally taken into account for the analysis. This correction is necessary because external factors also affect the measuring signals.

Services offered

- Monitoring of offshore foundation structures, e.g. for jacket or tripod foundations
- Crack detection at weld seams in onshore and offshore wind farms

Tomography for defect detection in weld seams on foundation structures of offshore wind turbines

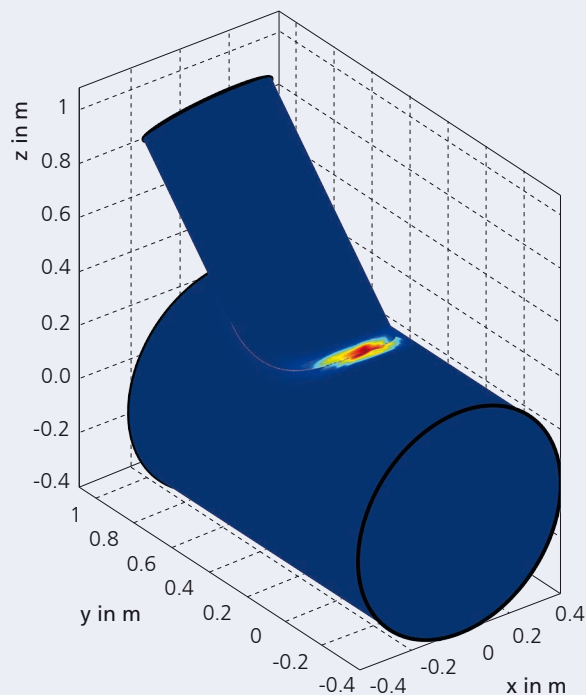

3 Sensor modules with embedded piezo transducers.

4 Sensor ring on a foundation structure in the Baltic 1 offshore wind farm.



TRANSPORTATION

Passenger and cargo volumes are growing globally. This means increased requirements for efficient monitoring systems, which must provide the highest possible level of safety. Fraunhofer IKTS develops such systems and services for the condition monitoring of components. They allow for recognizing damages in real time and repair it at an early stage to avoid serious consequential damage.

RAIL VEHICLES AND RAILWAYS

Methods and measuring systems for condition monitoring are used more and more often for rail vehicle components. Robust and autonomous solutions are needed for freight traffic in particular. Fraunhofer IKTS supplies systems for the monitoring of wheels and wheel bearings with the ability to detect blocked brakes, defective springs and excessive inclinations (e.g. due to incorrect loading).

The institute offers a measuring system for the monitoring of wheels of high-speed (ICE) trains integrated into the hollow shaft. Its working principle is based on high-frequency structure-borne noise generated by the contact between wheel and rail, while also making use of acceleration and temperature data. By adapting the signal processing algorithm, it becomes possible to monitor the railway tracks as well. The sensor nodes consist of modules for the sensors as well as signal processing and radio processes.

Services offered

- Hardware and signal processing software for the monitoring of rail vehicle components
- Measuring systems adapted for various applications
- Instrumentation and support of test drives

COMPOSITE MATERIALS IN AIRCRAFT CONSTRUCTION

With lower fuel consumption for passenger planes in mind, more and more OEMs use lightweight materials to reduce aircraft weight. However, the carbon fiber composite materials (CFRP) used for this often pose significant challenges with regard to processing, quality control and inspections.

Fraunhofer IKTS offers customized solutions for the system integration of sensors for condition monitoring, support of static and dynamic material fatigue tests, simulations of the propagation of elastomechanical waves in various materials, 3D laser vibrometry for the visualization of structural damage as well as statistical analyses for defect diagnosis and comprehensive signal processing techniques.

Services offered

- Development of customized SHM electronics
- Design of sensor layout, electronic components and test concepts for acoustic methods
- Development of signal processing algorithms for online diagnostics
- Ability to assume complete measuring tasks for component testing during development

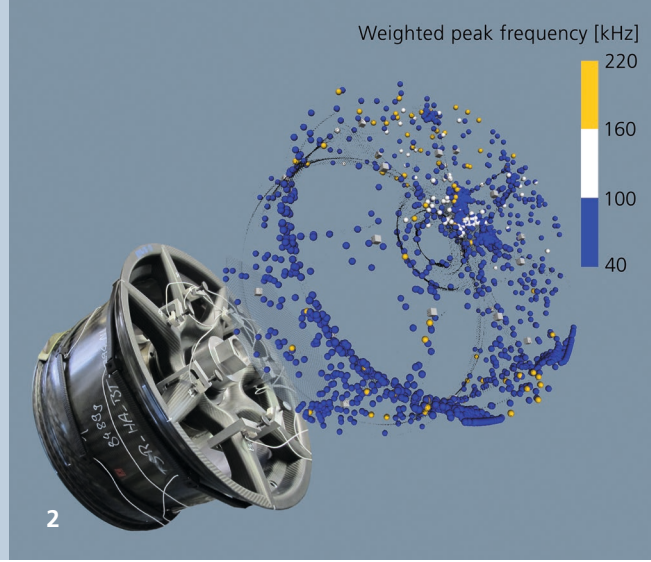
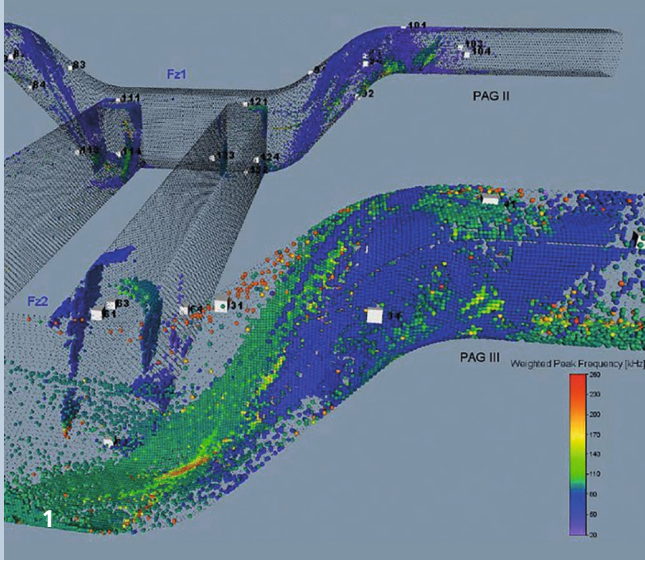

COMPLEX STRUCTURES IN AUTOMOTIVE ENGINEERING

Acoustic emission testing allows to quickly and safely determine which areas emit elastic waves due to external stress, e.g. from growing cracks. The location of the damage can be determined by the signals' travel time from the individual noise source to a number of sensors. This is followed by further analyses with conventional non-destructive test methods, or rather by tests with controlled parameters.

Specifically for lightweight structures in the automotive sector, IKTS has developed a monitoring system that can be integrated in complex components. This allows to monitor the fiber composite material more reliably than it is possible with conventional monitoring and inspection methods. Sensors and electronics are embedded in the manufacturing stage without affecting the structure. Near-surface integration ensures optimal coupling between sensor and test object.

Services offered

- Integration of condition monitoring measurements into existing production lines
- Support of measuring processes for static and dynamic material fatigue tests (from coupon samples to large-scale structures), e.g. bending fatigue test
- Simulations of the propagation of elastomechanical waves
- 3D laser vibrometry for the visualization of structural damage
- Statistical analyses for defect diagnosis
- Customized electronics development as well as reliable embedding of sensors without affecting the structure
- Design of sensor layout, electronic components and test concepts
- Provision of measuring equipment and devices on site
- Support in the evaluation of recorded measurement series

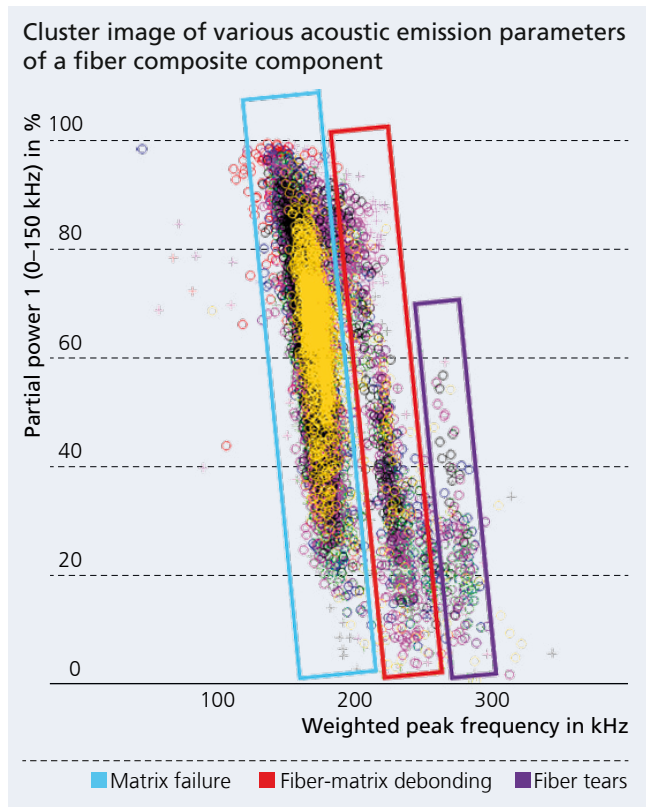

Acoustic emission analysis during stress tests:

- 1 on an undercarriage for a rail vehicle.
- 2 on CFRP wheels (source: Dr. Ing. h.c. F. Porsche AG).

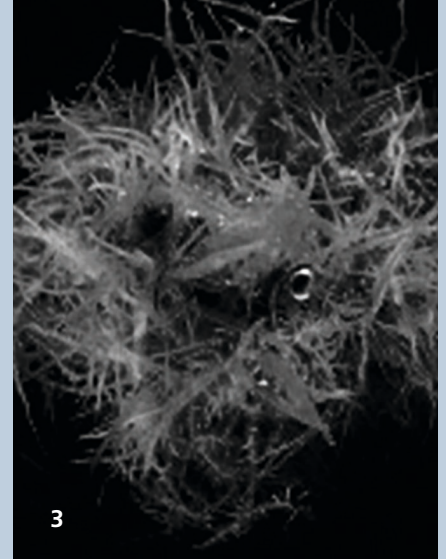
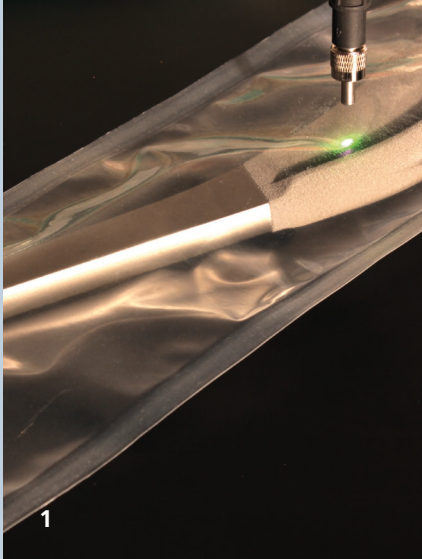

BIO- AND MEDICAL TECHNOLOGY

For the pharmaceutical and food industries, proving the purity of products and raw materials is an essential task. Fraunhofer IKTS transfers and implements the latest acoustic and optical diagnostic methods for industrial applications in systems for condition monitoring in bio- and medical technology. The aim is to increase quality standards without affecting standardized processes and procedures.

PROOF OF STERILIZATION FOR MEDICAL PRODUCTS

Irradiating surfaces with electrons (e-beam) is a successful method for sterilizing sensitive medical products made from thermolabile or functional biological materials.

Fraunhofer IKTS offers a novel optical inspection system to monitor the sterilizing process, which enables the indirect test of the electron beam sterilization. Its core elements are ceramic pigments in the packaging material which change their optical properties when treated with e-beam. The electron dose introduced is carried out by reading the optical pigment properties, either with a hand-held scanner or integrated into the process. In contrast with traditional solutions, e.g. film dosimeters, the evaluation does not have to take place after the process. It can be performed as the sterilizing process is taking place. This makes it possible to integrate the proof of irradiation into the e-beam unit. With a spatially resolved quality control of the irradiation procedure, it is also possible to perform targeted post-sterilization on defined surface areas.

Services offered

- Client-specific measuring and monitoring systems, from hand-held scanners to in-line tests
- Integration into existing process lines
- Feasibility studies and scientific consulting

MONITORING OF GRAIN DEPOTS

The sawtoothed grain beetle, the Indian meal moth, the flour beetle, the corn weevil, the lesser grain borer: pests such as these constitute a huge problem for agricultural businesses which store grain. They destroy vast amounts of food and grain reserves. It is therefore very important for farming businesses to be able to detect pest infestations in order to take appropriate measures.

Fraunhofer IKTS offers monitoring solutions for grain storage and associated transport systems. Biological signals from pests, such as feeding or crawling noises, are detected and classified with the help of algorithms. IKTS systems are based on methods of artificial intelligence (AI) and can make statements on the extent of the infestation, the type of pest and its development state (e.g. larvae/beetle).

1 *Optical method for monitoring the sterilization of a medical product.*

2 *AI-based pest detection in grain silos.*

3 *Hairy roots: speckle image with fractal dimension.*



4

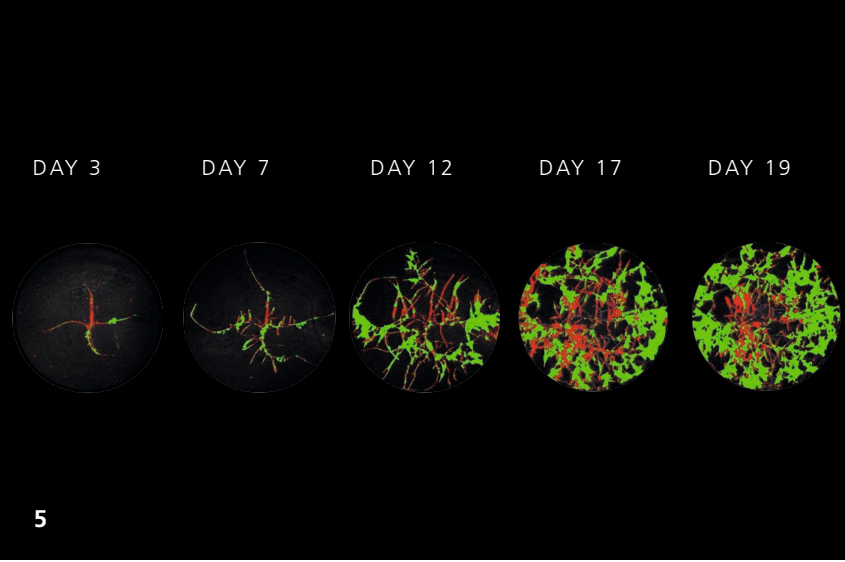

5

Services offered

- Sensors and systems for pest detection
- Customized systems for the monitoring of grain depots and transport systems

MONITORING OF BIOMATERIALS

As resources are becoming costly and less available in the future due to population growth in developing and emerging economies, as well as demographic changes in industrial nations, the competition for arable land increases. This is why more and more research and development activities focus the industrial production of plant-based cell and tissue cultures in bioreactors. These allow for the production of active agents and additives for use in the pharmaceutical, cosmetic and nutraceutical industries. The efficient management of biotechnological processes for such cultivation requires biomass concentration and growth kinetics to be determined accurately.

Hairy root cultures of plant-based secondary metabolites (substances with strong pharmaceutical and nutritional effect) are extremely important for enzyme recovery. The fact that their root segments are distributed unevenly means that it has been impossible to determine biomass accurately with commercially available methods until now.

With laser speckle photometry (LSP), Fraunhofer IKTS offers a non-invasive method for determining biomass concentration as well as various morphology parameters in heterogeneous biotechnological systems. The method works by identifying the "fracturing" of the biomass or hairy roots at a specific point in time. Root activity is then assessed using the speckle contrast. Thus, LSP as applied by Fraunhofer IKTS enables a more efficient recovery of active agents.

Services offered

- Development of customized biomonitoring systems including hardware and software
- System integration into existing process lines
- Feasibility studies and scientific consulting
- Measuring services

4 Image of a hairy root culture.

5 Detection of the change of speckle contrast over the cultivation period.



COOPERATION MODELS

Innovation and development are the cornerstones of a promising corporate future. In order to create a competitive edge, Fraunhofer offers tailored options for cooperation, so that companies can work together in the best possible way. This also allows to utilize development skills at short notice and as needed.

One-off contracts

The classic cooperation model is the one-off contract. A company perceives a need for research or development. A discussion with Fraunhofer IKTS identifies possible solutions and clarifies the form the partnership could take and the estimated cost.

Large-scale projects

Some challenges are so complex that they require multiple partners to develop a solution. Clients in this situation have access to the full range of Fraunhofer Institutes. It is possible to incorporate external partners and additional companies.

Strategic partnerships and innovation clusters

Pre-competitive research which starts off without any ties to specific development contracts often results in long-term partnerships with companies on a regional and international level.

Spin-offs

Fraunhofer researchers often take the step towards independence by founding their own company. Fraunhofer itself only participates in these kinds of start-ups up to a certain extent. Sometimes the customer who commissioned the new development is interested in taking a stake in the spin-off company.

Licensing models

Licenses are a way to give third parties permission to use certain industrial property rights under defined terms and conditions. This means that industrial clients can use Fraunhofer innovations for their products and portfolios.

Fraunhofer IKTS offers flexible licensing models for company-wide use, optimizing one's own portfolio, or for marketing one's services to third-party clients. The design of a license agreement depends on the boundary conditions of commercialization for the company in its respective market segment, and on the type of cooperation with Fraunhofer. Therefore, such offers are always negotiated on a case-by-case basis.



TECHNICAL EQUIPMENT

MAS – Multi-channel acoustic measurement system

- Different hardware platforms available for mobile or stationary applications
- Technology platform for dynamic acoustic emission testing with fatigue testing on objects of various materials (fiber composite materials, metals), geometries and dimensions
- Various numbers of channels per device for a customized sensor network possible (up to 32 channels per device and up to 16 devices in one network with up to 512 channels possible)
- Resolution: 12 to 16 bit
- Total sampling rate: 12.5 to 20 MHz
- Standard frequency range: 10 kHz to 5 MHz

AMSY-6 acoustic emission testing system and software by Vallen Systeme GmbH

- Static acoustic emission testing with fatigue testing on objects of various materials (fiber composite materials, metals), geometries and dimensions
- 19 slots with up to 38 AE channels
- Transient recorder module for the optional recording of waveforms
- Software for the analysis of acoustic emission parameters (AE data) and proven localization functions

Radio node

- Supports “acoustic emission” and “acousto ultrasonics” with synchronous triggering
- Frequency range: 868 MHz
- Resolution: 16 bit
- Sampling rate: 1 MS/s
- Time to synchronization: 1 μ s
- Integrated acceleration and temperature sensors

Polymer optical acoustic emission system

- Frequency range: 10 to 125 kHz
- Energy supply and data transfer from up to twelve sensor nodes on polymer optical basis
- Can be controlled via remote maintenance (WiFi, UMTS), no direct access for data reception and control required
- Software for the localization, statistical evaluation and visualization of acoustic emissions

Leica ScanStation C5

- Geometrical scanning, preferably large structures, e.g. wind turbines
- Range: up to 300 m
- Scan resolution: up to 1 mm
- Scan rate: up to 25,000 dots/s

3D laser vibrometer by Polytec

- Process and plant optimization through non-contact 3D vibration analysis
- 3D wave propagation to determine the radiation pattern of sensors
- 3D expansion measurement
- Non-contact measurement of structures
- Variable frequency range: 0 Hz to 1 MHz
- Modal analysis

Automated ultrasonic scan carriage

- Extensive scans of large measuring areas (up to 1 m width)
- Adaptation of various ultrasonic probes (resolution determined by frequency range)
- Splash-water proof

FRAUNHOFER IKTS IN PROFILE

The Fraunhofer Institute for Ceramic Technologies and Systems IKTS conducts applied research on high-performance ceramics. The institute's three sites in Dresden and Hermsdorf (Thuringia), Germany, collectively represent Europe's largest R&D institute dedicated to the study of ceramics.

As a research and technology service provider, the Fraunhofer IKTS develops advanced high-performance ceramic materials, industrial manufacturing processes as well as prototype components and systems in complete production lines up to the pilot-plant scale. In addition, the research portfolio also includes materials diagnostics and testing. The test procedures in the fields of acoustics, electromagnetics, optics and microscopy contribute substantially to the quality assurance of products and plants.

The institute operates in nine market-oriented business divisions in order to demonstrate and qualify ceramic technologies and components as well as non-destructive testing methods for new industries, product concepts and markets within and beyond the established fields of application. Industries addressed include ceramic Materials and Processes, Mechanical and Automotive Engineering, Electronics and Microsystems, Energy, Environmental and Process Engineering, Bio- and Medical Technology, Non-Destructive Testing and Monitoring, Water as well as Materials and Process Analysis.



www.ikts.fraunhofer.de

CONTACT

Industrial Solutions
Condition monitoring

Dr.-Ing. Lars Schubert
Fraunhofer Institute for
Ceramic Technologies and
Systems IKTS

Maria-Reiche-Strasse 2
01109 Dresden, Germany
Phone +49 351 88815-533
lars.schubert@
ikts.fraunhofer.de